

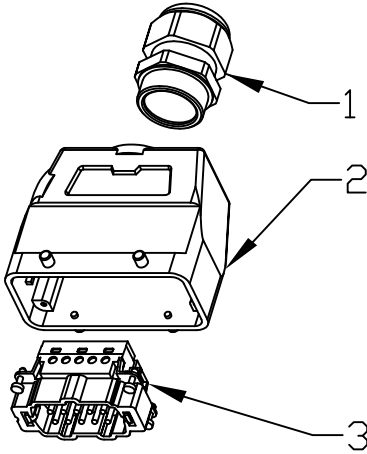

1351 W. Second Street
 Oconomowoc, WI 53066
 Phone: 262-567-2288
 Fax: 262-567-0857
 E-mail: sales@ductowire.com

1445 Norjohn Ct. Unit 10
 Burlington, Ontario, Canada L7L 0E6
 Phone: 905-331-2612; 800-361-WIRE (9473)
 Fax: 905-331-6639; 800-663-0933
 E-mail: dow@ductowire.ca

Duct-o-wire® Quick-Plug™ Components



QUICK PLUG™ HOOD KITS FOR ROUND CABLE

*20 AMP MAXIMUM				
PIN #	HOOD KITS	ITEM	PART NUMBER	DESCRIPTION
10 PIN	CT-8 HOOD KIT	1	CT-RCG1	CORD GRIP
		2	CT-10 HOOD	HOOD
		3	CT-10-M	10 PIN MALE PLUG
16 PIN	CT-16 HOOD KIT	1	CT-RCG2	CORD GRIP
		2	CT-16 HOOD	HOOD
		3	CT-16-M	16 PIN MALE PLUG
24 PIN	CT-24 HOOD KIT	1	CT-RCG3	CORD GRIP
		2	CT-24 HOOD	HOOD
		3	CT-24-M	24 PIN MALE PLUG

"IN LINE" QUICK PLUG™ & RECEPTACLE (PNR) KITS FOR ROUND CABLE

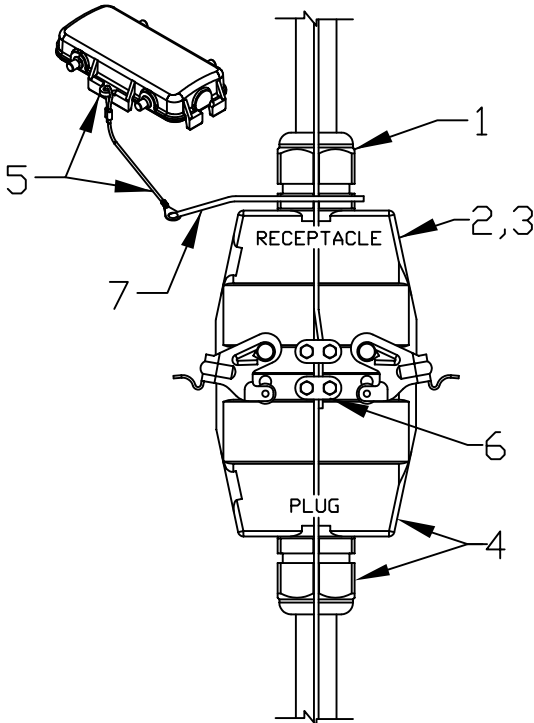

*20 AMP MAXIMUM				
PIN #	PNR KITS	ITEM	PART NUMBER	DESCRIPTION
10 PIN	CT-8 PNR	1	CT-RCG1	CORD GRIP
		2	19300100736	PNR BASE
		3	CT-10-F	10 PIN FEMALE REC
		4	CT-8 HOOD KIT	HOOD ASSEMBLY
		5	CT-8 COVER	COVER
		6	CT-SR HDW KIT	STRAIN RELIEF HDW
		7	TY-23M	TIE STRAP
16 PIN	CT-16 PNR	1	CT-RCG2	CORD GRIP
		2	19300160737	PNR BASE
		3	CT-16-F	16 PIN FEMALE REC
		4	CT-16 HOOD KIT	HOOD ASSEMBLY
		5	CT-16 COVER	COVER
		6	CT-SR HDW KIT	STRAIN RELIEF HDW
		7	TY-23M	TIE STRAP
24 PIN	CT-24 PNR	1	CT-RCG3	CORD GRIP
		2	19300240737	PNR BASE
		3	CT-24-F	24 PIN FEMALE REC
		4	CT-24 HOOD KIT	HOOD ASSEMBLY
		5	CT-24 COVER	COVER
		6	CT-SR HDW KIT	STRAIN RELIEF HDW
		7	TY-23M	TIE STRAP

FLAT CABLE TO ENCLOSURE QUICK PLUG™ INSTALLATION SINGLE CABLE

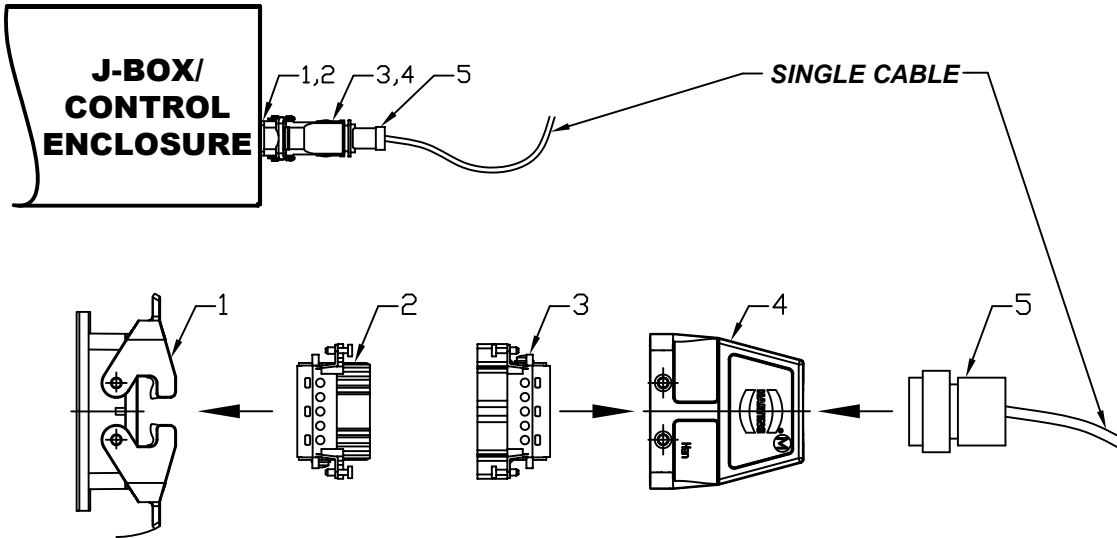

FLAT CABLE	MAX AMPS	# OF PINS	PART 1	PART 2	PART 3	PART 4	PART 5
FC-816	15	10	CT-8 PANELBASE	CT-10-F	CT-10-M	CT-10 H-32	CT-816C
FC-816	15	16	CT-16 PANELBASE	CT-16-F	CT-16-M	CT-16 HOOD	CT-816C
FC-1216	15	16	CT-16 PANELBASE	CT-16-F	CT-16-M	CT-16 HOOD	CT-1216C
FC-414	20	10	CT-8 PANELBASE	CT-10-F	CT-10-M	CT-10 H-32	CT-414C
FC-412	20	10	CT-8 PANELBASE	CT-10-F	CT-10-M	CT-10 H-32	CT-412C
FC-712	20	10	CT-8 PANELBASE	CT-10-F	CT-10-M	CT-10 H-32	CT-712C
FC-1214	17	16	CT-16 PANELBASE	CT-16-F	CT-16-M	CT-16 HOOD	CT-1216C
FC-814	17	10	CT-8 PANELBASE	CT-10-F	CT-10-M	CT-10 H-32	CT-816C
FC-812	20	10	CT-8 PANELBASE	CT-10-F	CT-10-M	CT-10 H-32	CT-812C
FC-414	25	6	CT-16 PANELBASE	1-1104205-1	1-1104204-1	CT-16 HOOD	CT-414C
FC-412	30	6	CT-16 PANELBASE	1-1104205-1	1-1104204-1	CT-16 HOOD	CT-412C
FC-410	35	6	CT-16 PANELBASE	1-1104205-1	1-1104204-1	CT-16 HOOD	CT-410C
FC-410	40	4	CT-16 PANELBASE	1102076-1	1102075-1	CT-16 HOOD	CT-410C
FC-48	50	4	CT-16 PANELBASE	1102076-1	1102075-1	CT-16 HOOD	CT-48C
FC-46	75	4	CT-16 PANELBASE	1102076-1	1102075-1	CT-16 HOOD	CT-46C
FC-44	80	4	CT-16 PANELBASE	1102076-1	1102075-1	CT-16 HOOD	CT-44C

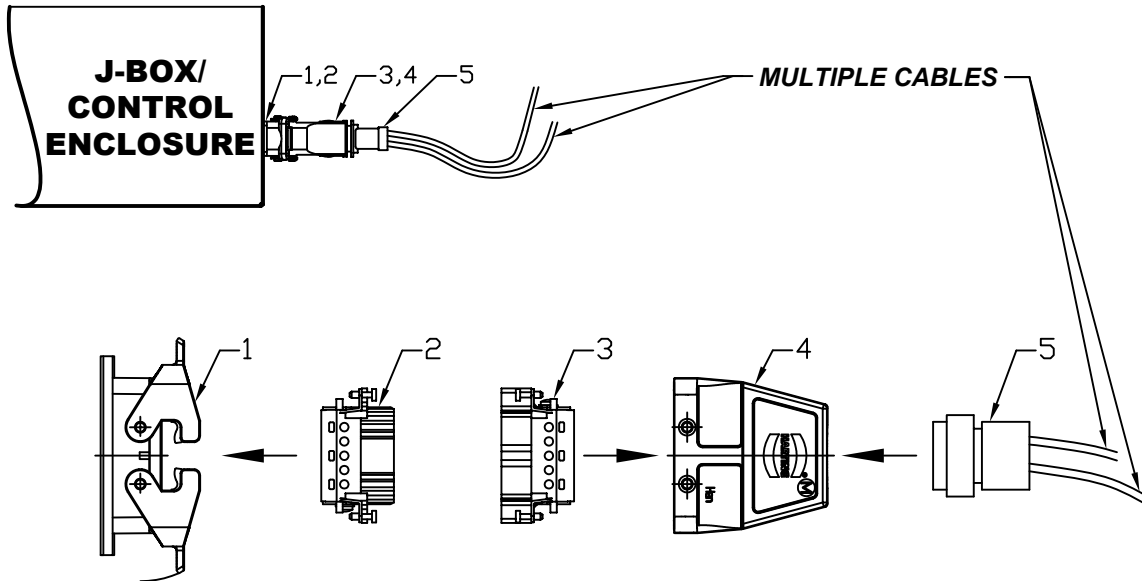

FLAT CABLE TO ENCLOSURE QUICK PLUG™ INSTALLATION MULTIPLE CABLES



FLAT CABLE	MAX AMPS	# OF PINS	PART 1	PART 2	PART 3	PART 4	PART 5
2X FC-816	15	16	CT-16 PANELBASE	CT-16-F	CT-16-M	CT-16 HOOD	CT-816C2
2X FC-814	17	16	CT-16 PANELBASE	CT-16-F	CT-16-M	CT-16 HOOD	CT-816C2
2X FC-1216	15	24	CT-24 PANELBASE	CT-24-F	CT-24-M	CT-24 HOOD	CT-1216C2
2X FC-1214	17	24	CT-24 PANELBASE	CT-24-F	CT-24-M	CT-24 HOOD	CT-1216C2
3X FC-814	17	24	CT-24 PANELBASE	CT-24-F	CT-24-M	CT-24 HOOD	CT-816C3
3X FC-816	15	24	CT-24 PANELBASE	CT-24-F	CT-24-M	CT-24 HOOD	CT-816C3
1X FC-414/412 AND 1X FC-1214 OR 1X FC-1216	20 17 15	16 16 16	CT-16 PANELBASE	CT-16-F	CT-16-M	CT-16 HOOD	CT-4/12C
1X FC-414/412 AND 1X FC-816 OR 1X FC-814	20 15 17	16 16 16	CT-16 PANELBASE	CT-16-F	CT-16-M	CT-16 HOOD	CT-4/8C

QUICK PLUG™ INDIVIDUAL COMPONENTS

FEMALE RECEPTACLE

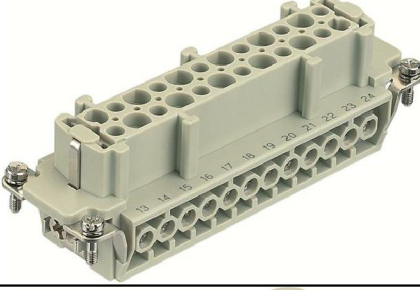
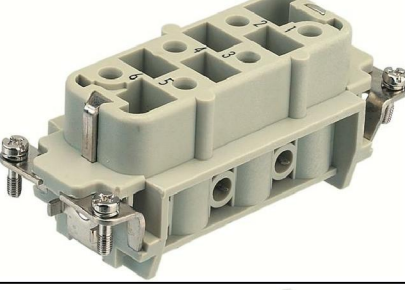
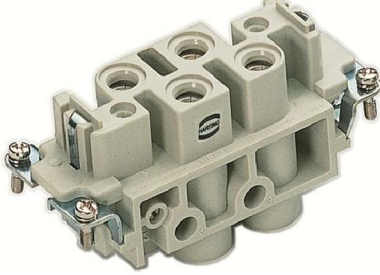
PART #	MAX AMPS	# OF PINS	DESCRIPTION	PICTURE OF PART
CT-10-F	20	10	10 PIN FEMALE RECEPTACLE	
CT-16-F	20	16	16 PIN FEMALE RECEPTACLE	
CT-24-F	20	24	24 PIN FEMALE RECEPTACLE	
1-1104205-1	35	6	6 PIN FEMALE RECEPTACLE	
1102076-1	80	4	4 PIN FEMALE RECEPTACLE	

CT-2013

DRAWINGS AND PICTURES ARE FOR ILLUSTRATION PURPOSES AND MAY NOT REPRESENT ACTUAL PRODUCT.

QUICK PLUG™ INDIVIDUAL COMPONENTS

MALE PLUG

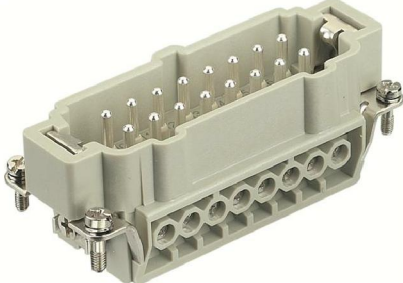
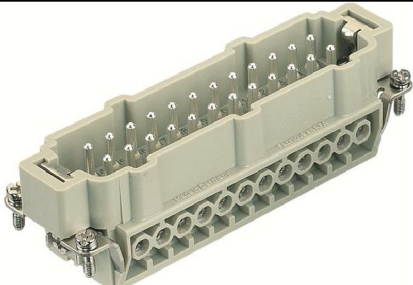
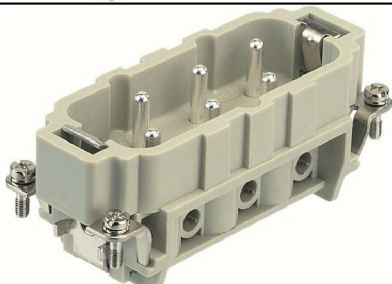
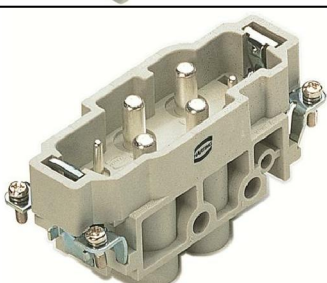

PART #	MAX AMPS	# OF PINS	DESCRIPTION	PICTURE OF PART
CT-10-M	20	10	10 PIN MALE PLUG	
CT-16-M	20	16	16 PIN MALE PLUG	
CT-24-M	20	24	24 PIN MALE PLUG	
1-1104204-1	35	6	6 PIN MALE PLUG	
1102075-1	80	4	4 PIN MALE PLUG	



QUICK PLUG™ INDIVIDUAL COMPONENTS

HOOD

PART #	THREADS	DESCRIPTION	PICTURE OF PART	NEMA RATING
CT-10 HOOD	M25	TOP ENTRY HOOD (ALSO USED FOR CT-8 HOOD KITS)		4/12
CT-16 HOOD	M32	TOP ENTRY HOOD		4/12
CT-24 HOOD	M32	TOP ENTRY HOOD		4/12
CT-10 H-32	M32	TOP ENTRY HOOD		4/12
CT-BMF HOOD	2X M25	DUAL TOP ENTRY HOOD		4/12



QUICK PLUG™ INDIVIDUAL COMPONENTS BASE & PANEL BASE



SURFACE BASE				
PART #	THREADS	DESCRIPTION	PICTURE OF PART	NEMA RATING
CT-10 BASE	M25	SURFACE MOUNT BASE		4/12
CT-16 BASE	M32	SURFACE MOUNT BASE		4/12
CT-24 BASE	M32	SURFACE MOUNT BASE		4/12

PANEL BASE				
PART #	DESCRIPTION	PICTURE OF PART	NEMA RATING	
CT-8 PANELBASE	PANEL MOUNT BASE CUT-OUT SIZE 1.375" X 2.500"		4/12	
CT-16 PANELBASE	PANEL MOUNT BASE CUT-OUT SIZE 1.375" X 3.375"		4/12	
CT-24 PANELBASE	PANEL MOUNT BASE CUT-OUT SIZE 1.375" X 4.375"		4/12	

QUICK PLUG™ INDIVIDUAL COMPONENTS

PNR BASE & COVER

PNR				
PART #	THREADS	DESCRIPTION	PICTURE OF PART	NEMA RATING
19300100736	M25	PNR BASE - 10 PIN		4/12
19300160737	M32	PNR BASE - 16 PIN		4/12
19300240737	M32	PNR BASE - 24 PIN		4/12

COVER			
PART #	DESCRIPTION	PICTURE OF PART	NEMA RATING
CT-8 COVER	DUST COVER FITS: CT-10 BASE CT-8 PANELBASE CT-8 PNR		4/4X/12
CT-16 COVER	DUST COVER FITS: CT-16 BASE CT-16 PANELBASE CT-16 PNR		4/4X/12
CT-24 COVER	DUST COVER FITS: CT-24 BASE CT-24 PANELBASE CT-24 PNR		4/4X/12